



45 Cowansview Road
Cambridge, Ontario, N1R 7L2

Phone: 855-658-4330
Fax: 855-658-9384

www.ecologix.ca
info@ecologix.ca

Installation Instructions

TW
Thru-wall condensing unit
R-410a

ECOLOGIX HEATING TECHNOLOGIES INC.
REV: 15022



45 Cowansview Road
Cambridge, Ontario, N1R 7L2













Phone: 855-658-4330
Fax: 855-658-9384

www.ecologix.ca
info@ecologix.ca

Contents

IMPORTANT NOTES FOR THE INSTALLER	3
TYPICAL CLOSET INSTALLATION	4
ELECTRICAL WIRING DIAGRAM	5
TW12 Wiring Diagram	5
TW18 Wiring Diagram	5
Two Stage TW2 - 18 & 24 and ACR24-2 Wiring Diagram	6
PHYSICAL PROPERTIES	7
INTRODUCTION	8
PRODUCT DESCRIPTION	8
<i>Cabinet</i>	8
<i>Coil</i>	8
<i>Fan and Motor</i>	8
<i>Compressor</i>	8
EQUIPMENT SELECTION AND SIZING	8
INSTALLATION	9
<i>Inspection</i>	9
<i>Location</i>	9
<i>Operating Environment</i>	9
<i>Mounting – Wall Sleeve</i>	9
<i>Mounting – Condensing Unit WITHOUT WALL SLEEVE</i>	10
REFIGERANT LINES – CHARGING	10
ELECTRICAL	12
<i>Low Voltage Control Wiring</i>	12
START-UP PROCEDURES	12
SERVICE AND MAINTENANCE	13
TROUBLESHOOTING	13
START UP INFORMATION AND TROUBLESHOOTING CHART	15
WARRANTY	16

IMPORTANT NOTES FOR THE INSTALLER

	A Quick Check List
	Is the wall sleeve installed square and caulked to the exterior wall?
	Is the grille installed?
	Is the base of the cabinet or sleeve sloped to the outdoors?
	Are the refrigerant lines connected at the air handler and condenser?
	Is the suction line insulated (Including sensing bulb)?
	Is the disconnect properly sized and installed according to local code?
	Is there an installation manual for the homeowner?
	Is the low voltage wire connected between the air handler and condenser?
	Are the service panels closed?
	Is the unit accessible? Are there clearances for service?
	Has the refrigerant charge been verified by measuring sub-cooling?

TYPICAL CLOSET INSTALLATION

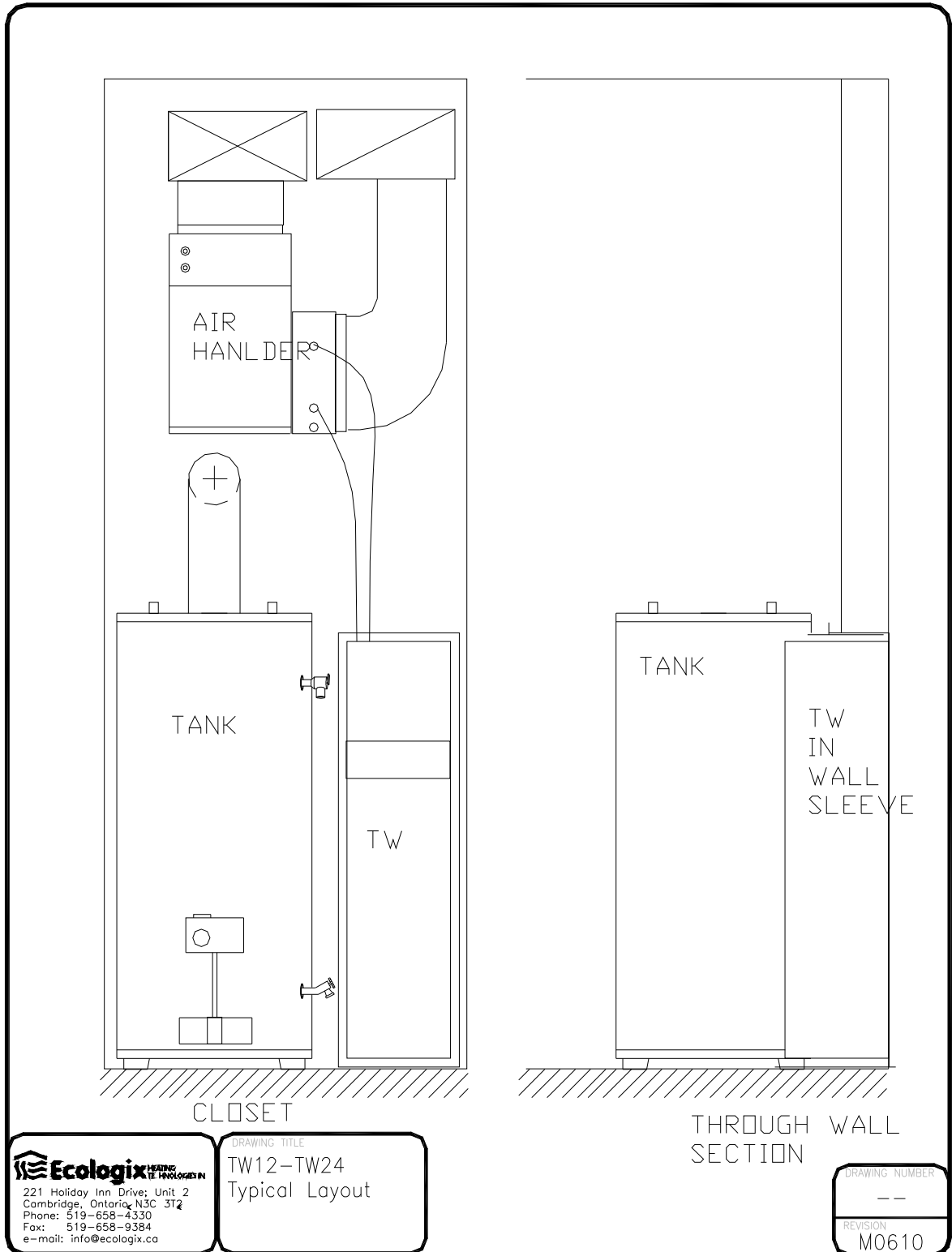

ELECTRICAL WIRING DIAGRAM

TW12 Wiring Diagram

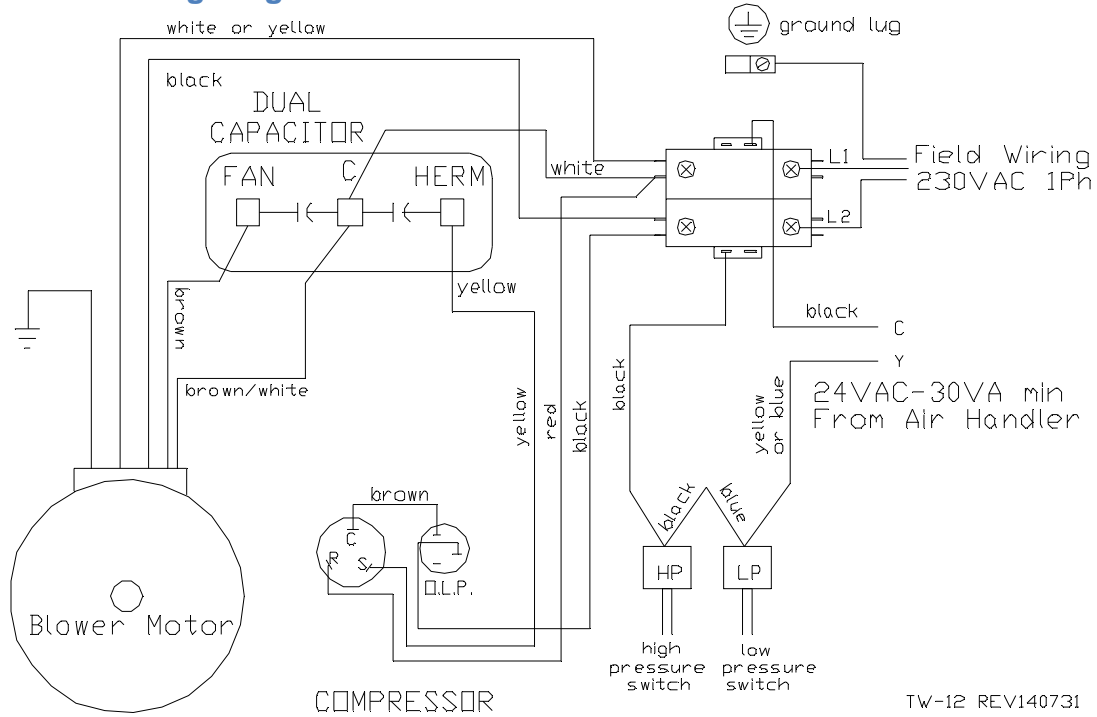

TW18 Wiring Diagram

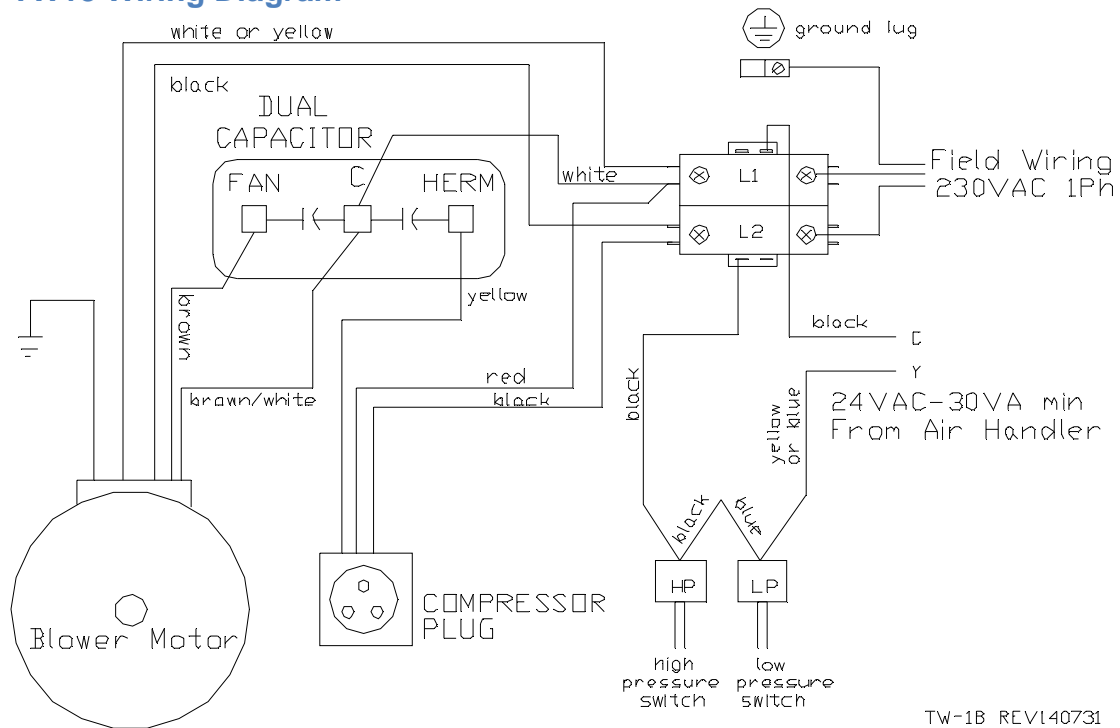

Two Stage TW2 - 18 & 24 and ACR24-2 Wiring Diagram

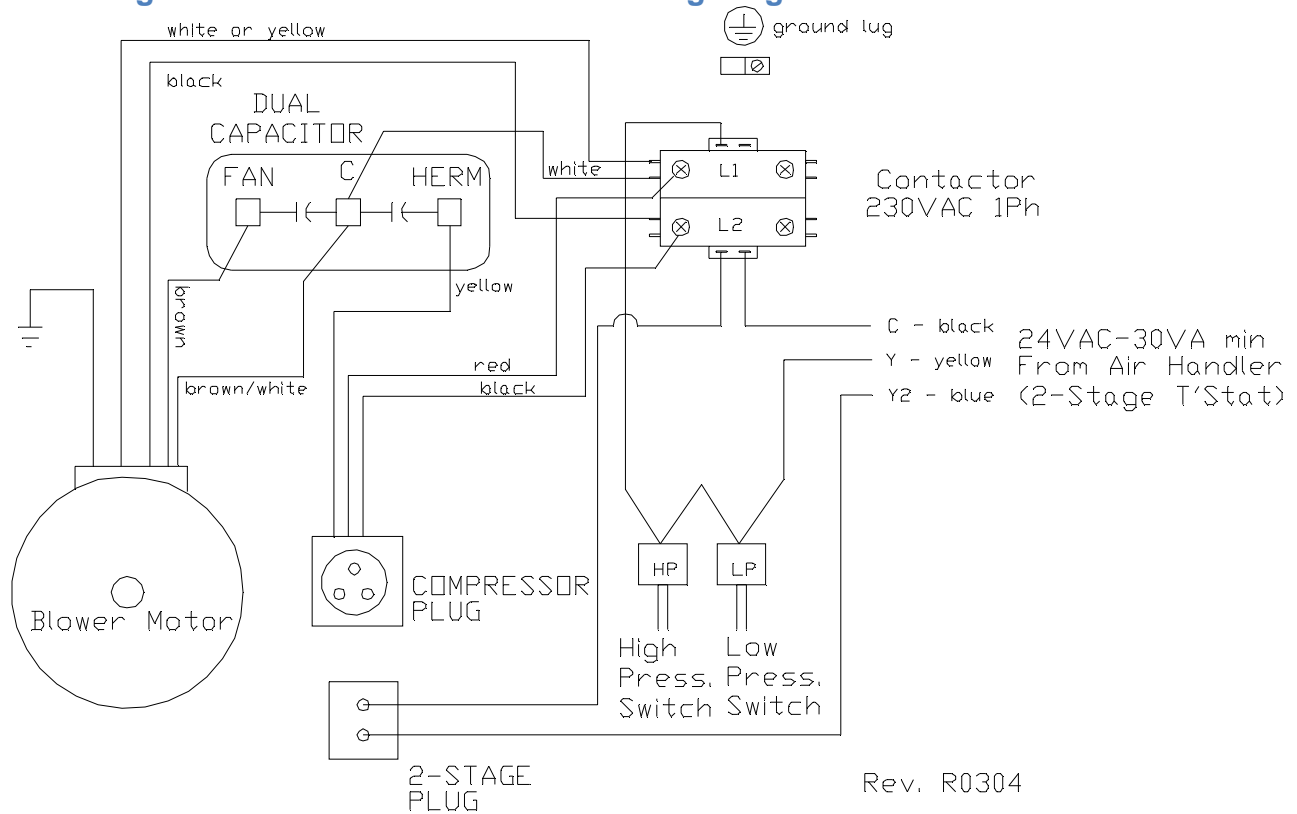

This diagram is provided as reference only. Wiring may differ depending on unit. Always refer to correct wiring diagram located on inside cover of electrical panel

Optional items that may be ordered separately or field installed:

- ICM220 solid state lock out
- Cold weather kit c/w/ fan control
- Low ambient lockout
- Crankcase heater

PHYSICAL PROPERTIES

Model	Capacity (tons)	Cabinet dimensions			Amps	Circuit Size (A)	Shipping Wt. (lb.)
		A depth	B width	C height			
TW-12	1.0	16"	14.25"	56"	8	15	125
TW-18	1.5	16"	14.25"	56"	12	20	135
TW-24	2.0	16"	14.25"	56"	16	30	138
TWSleeve		17.5"	14.5"	58.75"	--	--	35



INTRODUCTION

TW™ wall-sleeve condenser units are designed for use with Ecologix air handlers.

They provide the cooling capabilities of regular air conditioning condensers (“cubes” or “slim-line”) but can be installed through the wall and serviced from inside the dwelling. They are ideally

suited to high-rise buildings where exterior space and accessibility can be major issues.

The cabinets are narrow to maximize exterior wall and window space and allow for closet installations of side by side AC, air handler and water heater.

PRODUCT DESCRIPTION

Cabinet

All cabinets have a tough, durable low maintenance G90 galvanized finish.

Cabinet dimensions are compact and narrow to provide maximum installation flexibility. Refer to product specifications and installation requirements for more details.

A variety of grilles are available to compliment the building exterior.

Coil

All coils and internal piping conform to ASTM B68 or ASTM B88 standards.

High-density aluminum fins provide maximum heat transfer for small coil surface.

Fan and Motor

All fans are wide body dynamically balanced for extra quiet operation.

Compressor

Small compressors are available to closely match room loads in small or energy-efficient spaces.

EQUIPMENT SELECTION AND SIZING

Proper sizing of system components is crucial for proper operation.

Steps for sizing and selection:

- 1) Obtain room by room heat gain
- 2) Select a condenser equal to 80%-120% of the total heat gain.

3) Select a matching evaporator coil for capacity and refrigerant.

5) Select an air handler of suitable air capacity based on pressure drop of the coil.

Note: over-sizing of cooling equipment results in inefficiency, short cycles and poor humidity control.

INSTALLATION

WARNING !

Installation should only be performed by qualified personnel. In addition to this manual, all local codes shall be followed.
Improper installation may void all warranties.

Detailed instructions are shipped with all accessory items and should be followed.

Inspection

Carefully uncrate the equipment. Ensure that the rated voltage and capacity on the nameplate matches the requirement for the installation. If there is damage to the machine, a claim must be made to your carrier immediately. Shipping damage is the responsibility of the purchaser to file all necessary documents with their carrier. Remove any shipping materials.

Location

Consideration must be given to location. The machine must be mounted in an area with adequate clearance and access for servicing. Consideration must also be given to noise and vibration that is normal for operation of this unit. Additional isolation may be required in occupant sensitive locations.

If the machine is installed in a closet or behind a sealed panel, there must be adequate provision for service (2 ft./60cm).

For installation in a concrete, brick or block wall; the wall sleeve must be used.

For installation in a wood frame wall, including face brick with proper lintel, the wall sleeve can be omitted. The entire base of the condenser unit must be supported. The cabinet shall be caulked in place at the exterior.

Allow at least six feet clearance in front of the grille outdoors for proper air circulation and heat dissipation.

Operating Environment

Do not install in a corrosive environment containing chlorine, fluorine, solvents or other corrosive chemicals. Do not install in any atmosphere containing explosive or flammable vapours.

Internal controls should not be exposed to temperatures above 105°F/41°C and should not operate in a condensing environment.

If the cooling unit is to be operated at temperatures below 50°F/10°C, a cold weather kit must be installed.

Mounting – Wall Sleeve

Assemble and install the wall sleeve according to the instruction sheet provided with the wall sleeve. The wall sleeve should be square and installed

flush to the outdoor finished wall surface. The wall sleeve can be fastened through the inside face of the sides to the building framing with #10 pan head screws. Do not screw through the base of the wall sleeve. The base of the wall sleeve has the required slope built in to match the slope of the Wall sleeve condenser to provide adequate drainage. There is no need to slope the condenser outward for drainage. The entire base of the wall sleeve should be properly supported. Provide flashing and seal outside edge of cabinet to wall to ensure a watertight finish. Make sure drip edge at bottom extends beyond wall finish.

Remember to rough-in refrigerant lines, power wire and control wire before completing interior finishes. Looking at the cabinet through the access panel, the preferred rough-in location is left side for refrigerant lines and right side for electrical.

The interior may be finished tight to the wall sleeve. Cabinet is designed to fit flush with back of wall sleeve when installed.

REFRIGERANT LINES – CHARGING

WARNING !

Refrigerant lines are to be connected by qualified personnel only. Improper installation can result in injury or improper operation of the equipment.

Slide the condenser into the wall sleeve. Remove all three service panels. The TW comes with the refrigerant lines stubbed out the top left side of the cabinet when facing the access panel. The service valves are located in the exterior of the cabinet accessible through the lower access panel

Mounting – Condensing Unit WITHOUT WALL SLEEVE

In many projects the thru wall condenser is installed without the sleeve.

Screw the grille to the face of the condenser wall sleeve if the sleeve is used.

Remove all three service panels. Shim the wall sleet to sit flush and square in the opening. Flush the face of the frameless grill with the outside finish of the opening. Please note the bottom of the wall sleeve has the required slope to provide drainage out the front. Fasten the condenser to the wall opening framing from the INSIDE of the condenser unit. Do not drill from the outside into the condenser cabinet. Make sure the edges of the louver is appropriately finished and flashed to avoid water penetration around the grille into the wall. Do not worry about water penetration into the unit itself. It is designed to drain.

other line-set lengths, add or subtract 0.4 oz of refrigerant per foot of line.

Where the evaporator and TW unit are separated by more than 20 feet vertically, loop the refrigerant to form a trap every 16 feet. The evaporator height above or below the compressor shall not exceed 40 feet vertically.

The equivalent length from the condenser to the evaporator shall not exceed 140 feet, including elbows and fittings. For the TW12 rotary compressor, the line lengths shall not exceed 40 feet. And the evaporator height above or below the TW 12 compressor shall not exceed 15 feet vertically.

Insulate the vapour (suction) line with suitable pipe insulation.

The correct refrigerant charge is listed on the rating plate for each unit. Information for charging is contained on the inside

panel of the unit

Test ports are available at the middle service panel so the system can be run with gauges hooked up and the doors on. All Ecologix matched coils use a TX valve for refrigerant expansion. The correct charge is verified by measuring the sub-cooling at the condenser discharge.

Space is allowed at the top of the sleeve to clip on temperature sensor. Once system is operating check that the correct charge is installed by measuring liquid line from condenser. Sub cooling should be 10F +5F /- 3F. If it is outside of this range, add or remove refrigerant from the liquid side as required.

Model	Liquid Line	Suction Line (Vapor)		
		Up to 40 feet	40-80 feet	80 - 140 feet
TW12	1/4 in.	1/2 in.	NA	NA
TW18	3/8 in.	5/8 in.	5/8 in.	5/8 in.
TW24	3/8 in.	5/8 in.	5/8 in.	3/4 in.

ADJUSTMENT FOR CAPACITY FOR LONG LINE SETS

Nominal capacity (Btuh)	Vapor line diameter (in.)	Equivalent Line Length (FT)				
		50	75	100	125	140
12,000	1/2	NA	NA	NA	NA	NA
18,000	5/8	0.99	0.97	0.96	0.95	0.95
24,000	5/8	1.00	0.99	0.99	0.98	0.97

Equivalent lengths of fittings (Add to measured length)

Type of elbow fitting	Inside Diameter (in.)		
	5/8	3/4	7/8
90° short radius	1.4	1.7	2
90° long radius	1.3	1.5	1.7
45°	0.6	0.7	0.8

ELECTRICAL

WARNING !

Make sure unit is properly grounded. Locate condensing unit on a separate electric circuit. Provide a line of site disconnect according to local code requirements.

The wiring diagram is located on the service door. A copy is provided in this document for reference only. Nameplate data is located on the side of the unit. Ampacity is also shown in the specification table. If there is a difference in ampacity and circuit size between the rating plate and this document, the rating plate shall be followed.

All condensers operate on 230VAC/1ph/60hz line voltage. All control circuits are 24 VAC.

Use copper conductors only. Connect power wires to terminal lugs in the control (middle) panel. Protect and seal

wires where they enter the condenser cabinet.

Low Voltage Control Wiring

Connect low voltage control wire, such as thermostat wire, between the low voltage terminals of the middle panel and the terminals of the air handler. Typical air handler terminal labels would be AC or Y & C. Protect and seal wires where they enter the condenser cabinet.

START-UP PROCEDURES

1. Verify power is connected to the condensing unit and the air handler.

2. Verify control wire is connected from the air handler to the condenser unit. Verify that the thermostat is installed.

3. Verify that refrigerant lines are connected between the air handler and condenser unit, evacuated and properly charged.

4. Install the upper and lower service panel of the condenser unit. Install all panels and filters at the air handler.

5. Turn on the power to the air handler and condenser unit. Set the room thermostat for cooling to energize the fan

and condenser. Note: some thermostats and air handlers have a five minute lock-out delay.

SERVICE AND MAINTENANCE

WARNING !

Service should only be provided by qualified personnel. Disconnect electrical supply before opening service panels.

Wiring

Examine wires for signs of pinching, fraying or charring. Replace as necessary.

reduce noise and improve the capacity and efficiency of the cooling system.

Coil

Examine the condenser coil for lint, debris or damage. Wash or vacuum if necessary.

If oil ports are present on the motor, the fan motor requires oil. Oil with an SAE 20 non-detergent oil. Plastic caps on the end bell of the motor must be removed and five drops of oil added. Failure to oil the motor may result in its seizing up and over oiling can cause secondary bearing damage or a buildup of lint and debris that can adversely affect the operation of the motor and fan.

Fan and motor

Check fan for dust once a year. The fan is accessible and removable through the top panel. If dirty, vacuum to remove dust. Keeping the fan blades clean will

TROUBLESHOOTING

WARNING !

Service should only be performed by qualified personnel. Take proper care to disconnect voltage supply. Use caution when working near charged capacitors.

Symptom	Cause	Check
Fan and compressor will not operate	<ol style="list-style-type: none"> 1. Power off 2. Improperly wired 3. Loose connections 4. 24vac supply 5. Thermostat 6. Firestat/Freezestat 	<ol style="list-style-type: none"> 1. Check main fuse/circuit breaker and remote disconnect. Measure power and control voltages at condenser. 2. Check power and control wiring. Refer to wiring diagram. 3. Check wiring.

		<ol style="list-style-type: none"> 4. Measure voltage and check ampacity (should be at least 40VA, replace transformer if faulty or under-sized. 5. Thermostat or air handler may have a delay of up to five minutes. Check thermostat settings. Disconnect thermostat and apply 24vac directly from air handler. If it operates, fault is at thermostat or a.h. control. 6. Determine cause of trip. Repair/reset/replace Firestat/freezestat if necessary.
Fan operates, compressor does not	Safety lock-out	<ol style="list-style-type: none"> 1. Reset thermostat
Compressor hums, won't start	<ol style="list-style-type: none"> 1. Low voltage or wrong voltage 2. Capacitor problem 	<ol style="list-style-type: none"> 1. Check wiring and voltage at unit, check wire size, check for loose wires. 2. Test compressor capacitor, replace if necessary
Fan starts but cuts out	<ol style="list-style-type: none"> 1. Incorrect or low voltage 2. Capacitor problem 3. Doesn't turn freely 4. Seized 5. High internal amperage 	<ol style="list-style-type: none"> 1. Check wiring and voltage at unit, check wire size, check for loose wires. 2. Test fan capacitor, replace if necessary 3. Oil motor, check bearings, replace fan motor if necessary. 4. Replace fan motor 5. Change to lower fan speed
High suction pressure	<ol style="list-style-type: none"> 1. Excessive evap. Air 2. Excessive load 3. High latent heat 	<ol style="list-style-type: none"> 1. Confirm correct amount of evap. Air, adjust air handler air flow. 2. Estimate space cooling load and compare to unit capacity. Replace with larger cooling unit if necessary. 3. Estimate space cooling latent load and compare to unit latent capacity.
High discharge pressure	<ol style="list-style-type: none"> 1. Insufficient air over condenser. 2. Plugged or restricted air over condenser coil 	<ol style="list-style-type: none"> 1. Adjust condenser fan speed. 2. Wash or vacuum condenser coil.

If you require diagnostic assistance, complete the Troubleshooting chart and send to your distributor.

START UP INFORMATION AND TROUBLESHOOTING CHART

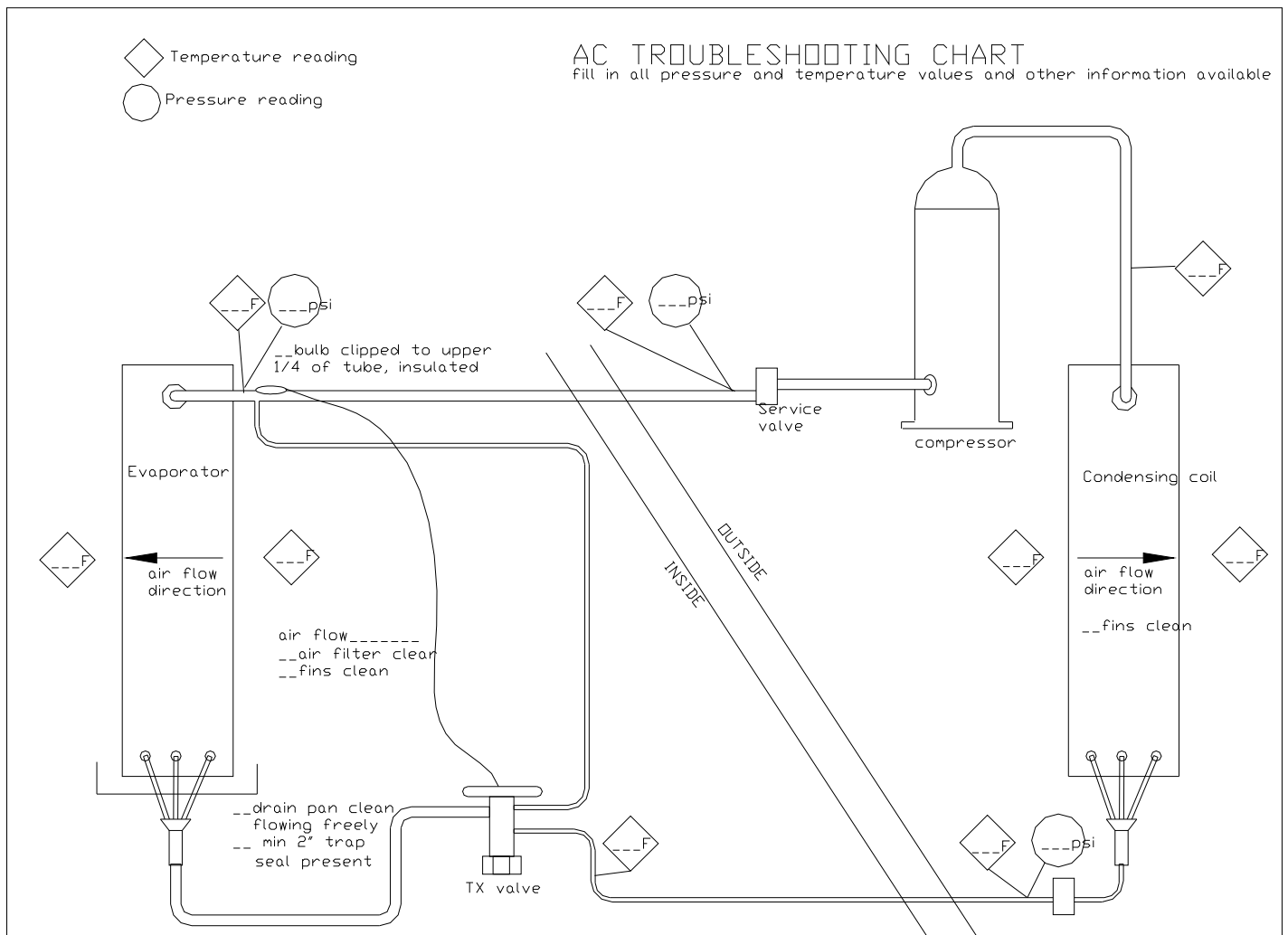

START UP INFORMATION SHEET

WARRANTY

This product is warranted by Ecologix Heating Technologies Inc to be free from defects in materials and workmanship that affect product performance under normal use and maintenance within the applicable periods specified below. Replacements furnished will carry only the un-expired portion of the original warranty.

Two-Year Parts

Ecologix Heating Technologies Inc will provide replacement parts for ANY part that fail within two years of purchase, subject to the **terms** below.

Five-Year Parts

Ecologix Heating Technologies Inc will provide replacement parts for compressor, refrigerant coil, cabinetry and piping that fail within five years of purchase, subject to the **terms** below.

Terms

- ❖ Reasonable proof of original purchase date must be provided in order to establish the effective date of the warranty, failing which, the effective date will be based on the date of manufacture plus thirty days.
The warranty does not cover failure or damages caused by:
 - improper installation or operation
 - accident, abuse or alteration
 - operation of device at temperatures or pressures outside of the rated capacities
 - corrosive operating environment
 - equipment moved from original installation location
- ❖ Replacements furnished under this warranty will be F.O.B. Ecologix Heating Technologies Inc product distribution points in the United States and Canada. They will be invoiced at regular prices. The account will be credited the full amount when the defective part is received by Ecologix, examined and approved as a valid warranty.
- ❖ Warranty applies to the original purchaser, but may be transferred to another owner provided the equipment is not moved from the original installation site.
- ❖ This warranty does not apply to labour, freight or any other cost associated with the service repair or operation of the product.
- ❖ Ecologix shall not be liable for any direct, special, incidental or consequential damages caused by the use, misuse, or inability to use this product.
- ❖ Ecologix is under no legal obligations to rectify, including but not limited to, lost profits, downtime, good will, damages to, or replacement of equipment and property
- ❖ Purchaser assumes all risk and liability of loss, damage or injury to purchaser and purchaser's property and to others and their property arising out of the use, misuse or inability to use this product.